

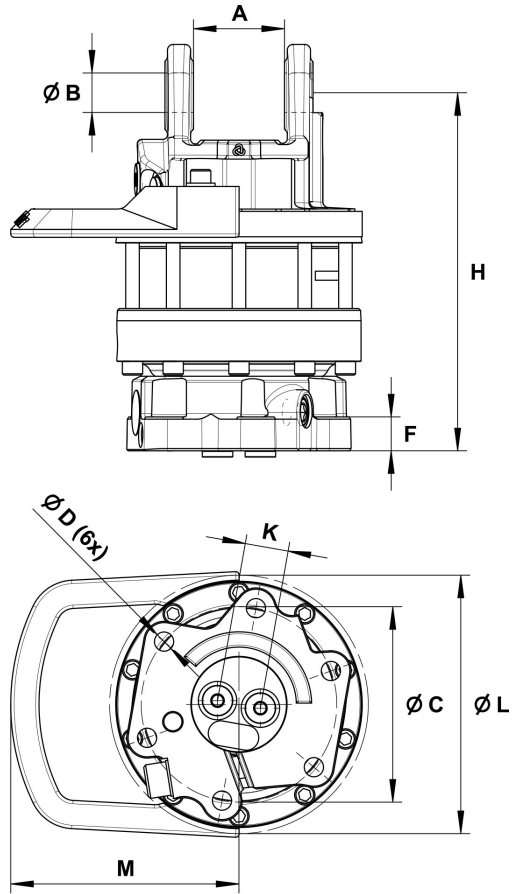

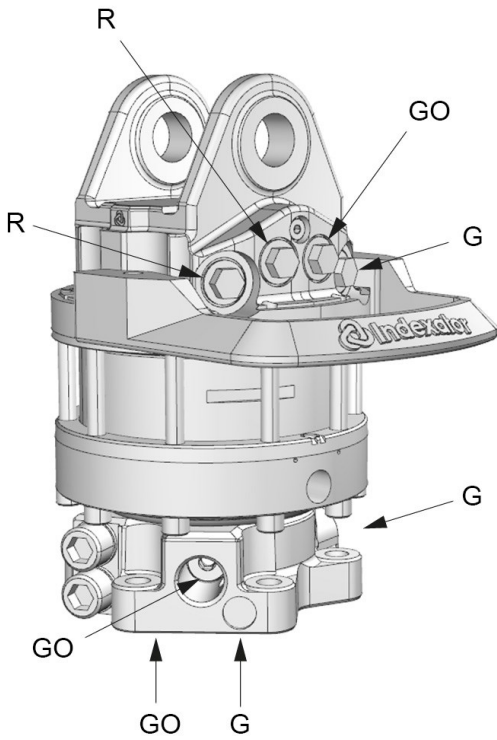







GV 12

Part No.: 5212049



Upper connection	Lower connection
G 1/2	G 1/2

A: 80,5 mm	B: Ø35 mm	C: Ø173 mm	D: Ø17 mm	F: 30 mm	H: 317 mm	K: 38,5 mm	L: Ø229 mm	M: 202 mm
---------------	--------------	---------------	--------------	-------------	--------------	---------------	---------------	--------------

 54.5 kg	 360°	 Max 100 kN	 Max 50 kN	 2200 Nm	 Max 25 l/min	 Max 25 MPa	 Max 25 MPa	 Max 25 MPa
--	---	--	---	--	---	--	--	--

Adapter sets are available for alternative connections.

We reserve the right to make product changes. For further technical information relating to integration and hydraulic connections, please contact rotator@indexator.com